

# Pipette Tips

WATSON

- Pipette Tips
- Empty Racks
- Others

# NEXTY NEXTY RACK/NEXTY PACK

Labs Essential  
Towards a Sustainable Society



## NEXTY RACK



### Autoclavable - Repeatedly

Designed for "durable" and "repeated autoclaving" due to polycarbonate used.

\*Repeated autoclaving may cause rack damaged.



### Stable Shape

Trapezoid shape allows tips to fit into the rack without holding the rack by hand.



### Non-Slip Rubber Base

Removable elastomer rubber base\* enhances stability. (\*Not autoclavable)



### Water drain holes

4 drain holes on the bottom allows quick drying after autoclaving.

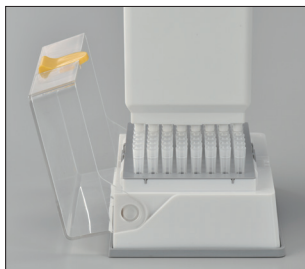

### Hinged lid

The lid opens wide enough to access to the tips even with multi channel pipette.



### One Touch Operation

Easy opening and closing the lid with one finger. The lid automatically locks when closed.



### Color-selectable Lock Latch

Select from 3 color options\* for easy identification. (\*3 pcs are originally included.)



### Easy to Refill

Refill plates are available for easy and convenient replenishing tips.

\*In case of setting the refill plate or stack rack except 123NT-755C, take the existing support post off before replenishing tips.

## NEXTY RACK S-size



1298-NTS  
NEXTY Rack (S)

Note: Color-selectable Lock Latch(3 pcs) and Support Post(See the photo down in the right) are originally included.

## NEXTY RACK M-size



1298-NTM  
NEXTY Rack (M)

Note: Color-selectable Lock Latch(3 pcs) are originally included.

Cat. No.	Item	Unit	Case
1298-NTS	NEXTY Rack (S)	1 piece	40 units

**Compatible refill plate and stack rack**

- 122-207C/CS ● 122-204C/CS ● 123R-254CS
- 123NT-755C ● 123R-755CS
- 122-703C/CS ● 122-503C/CS
- 122-505C/CS
- 127-10S ● 127-10XS ● 127-20S ● 127-100S ● 127-200S
- 1272-207CS ● 1271-204CS ● 126-20S ● 126-100S ● 1272-703CS
- 126-300S

Material: Polycarbonate (rack/support post)  
Polybutyleneterephthalate (lock latch)  
Elastomer (rubber base)



Body/Lock latch only

Cat. No.	Item	Unit	Case
1298-NTM	NEXTY Rack (M)	1 piece	20 units

**Compatible refill plate and stack rack**

- 122-706C/CS ● 122-804C/CS ● 122-806C/CS
- 123R-757CS
- 127-1000S
- 126-1000S

Material: Polycarbonate (rack)  
Polybutyleneterephthalate (lock latch)  
Elastomer (rubber base)



Body/Lock latch only

## NEXTY PACK

**Ecology & Economy**  
**Waste-reduction due to paper package**  
**Space-saving, Cost-saving**  
**Very easy to refill tips**



After setting into tip rack



123NT-755C  
NEXTY Pack 200 µL  
Refill plate for NEXTY Rack S size

Material: Polypropylene (pipette tip)  
Polycarbonate (plate)  
Paper (box)

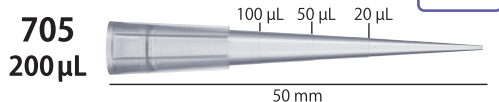

Ultrathin formed tip point enables complete liquid dispense.

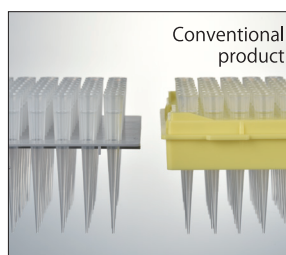

Thin wall designed plate reduces waste compared to conventional product.



Place the Support Post\* inside the NEXTY Rack(S size) before use. (\*Originally included)



Easy to refill tips.



Cat. No.	Item	Unit	Case
123NT-755C	200 µL, Standard Tip, Graduated, Natural, "NEXTY PACK" Refill Stack for NEXTY Rack(S)	96 tips × 5 plates × 10 stacks	5 units

**Pipette tip compatibility**

- Watson NEXTY/NEXTY-S 2-20 µL / 10-100 µL(Multi) / 20-200 µL(Multi) / 20 µL · 100 µL · 200 µL(Fixed volume)
- Eppendorf Reference/ Research V 2-20 µL / 10-100 µL(Multi) / 50 (20) -200 µL
- Gilson Pipetman P-20 / P-100 / P-200 • Finnpipette Digital 2-20 µL / 5-50 µL(Multi) / 10-100 µL / 20-200 µL
- Biohit Proline 2-20 µL / 5-50 µL(Multi) / 10-100 µL / 20-200 µL
- Nichiryo Nichipet EX 2-20 µL / 10-100 µL / 20-200 µL / 5-50 µL(Multi) / 40-200 µL(Multi) • A&D MPA-200



NEXTY Rack / NEXTY Pack

Refill plates

# ECO PACK



1000µL

200µL

10µL



Material: Polypropylene (pipette tip/plate/upper lid)  
Paper (box)

**Environmentally-friendly**  
**Sterilized**  
**Space-saving & Cost-saving**

### Easy to refill



Lift a plate

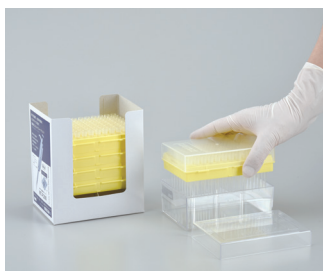

Place it into a rack



Refilling tips is completed

10 $\mu$ L



123R-254CS  
Box size:  
W122mm × D89.5mm × H134mm

### 10 $\mu$ L Short Tip

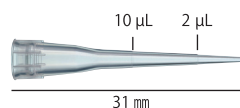

Real scale



\*: see below



Empty Rack for ECO PACK (10  $\mu$ L)  
1298-254RA  
Material: Polycarbonate



Cat. No.	Item	Unit	Case
123R-254CS	10 $\mu$ L, Short Tip, Graduated, Natural, "ECO PACK" Refill Stack	Sterilized 96 tips × 5 plates × 10 stacks	5 units
1298-254RA	Empty Rack for ECO PACK (10 $\mu$ L)	10 racks	10 bags

**Pipette tip compatibility** • Watson NEXTY/NEXTY-S 0.2-2  $\mu$ L / 1-10  $\mu$ L (Multi) / 10  $\mu$ L (Fixed volume)  
• Eppendorf Reference/ Research V 0.1-2.5  $\mu$ L / 0.5-10  $\mu$ L (Multi)  
• Gilson Pipetman P-2 / P-10 • Finn pipette Digital 0.2-2.0  $\mu$ L / 0.5-10  $\mu$ L (Multi)  
• Biohit Proline 0.5-10  $\mu$ L (Multi) • Nichiryo Nichipet EX 0.1-2  $\mu$ L / 0.5-10  $\mu$ L (Multi) • A&D MPA-10 / MPA-20

200 $\mu$ L



123R-755CS  
Box size:  
W122mm × D89.5mm × H134mm

### 200 $\mu$ L Standard Tip

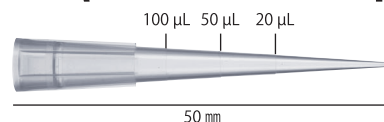

Real scale



\*: see below



Empty Rack for ECO PACK (200  $\mu$ L)  
1298-755RA  
Material: Polycarbonate



Cat. No.	Item	Unit	Case
123R-755CS	200 $\mu$ L, Standard Tip, Graduated, Natural, "ECO PACK" Refill Stack	Sterilized 96 tips × 5 plates × 10 stacks	5 units
1298-755RA	Empty Rack for ECO PACK (200 $\mu$ L)	10 racks	8 bags

**Pipette tip compatibility** • Watson NEXTY/NEXTY-S 2-20  $\mu$ L / 10-100  $\mu$ L (Multi) / 20-200  $\mu$ L (Multi) / 20  $\mu$ L-100  $\mu$ L-200  $\mu$ L (Fixed volume)  
• Eppendorf Reference/ Research V 2-20  $\mu$ L / 10-100  $\mu$ L (Multi) / 50(20)-200  $\mu$ L  
• Gilson Pipetman P-20 / P-100 / P-200 • Finn pipette Digital 2-20  $\mu$ L / 5-50  $\mu$ L (Multi) / 10-100  $\mu$ L / 20-200  $\mu$ L  
• Biohit Proline 2-20  $\mu$ L / 5-50  $\mu$ L (Multi) / 10-100  $\mu$ L / 20-200  $\mu$ L  
• Nichiryo Nichipet EX 2-20  $\mu$ L / 10-100  $\mu$ L / 20-200  $\mu$ L / 5-50  $\mu$ L (Multi) / 40-200  $\mu$ L (Multi) • A&D MPA-200

1000 $\mu$ L



123R-757CS  
Box size:  
W137mm × D96mm × H216mm

### 1000 $\mu$ L Long Tip

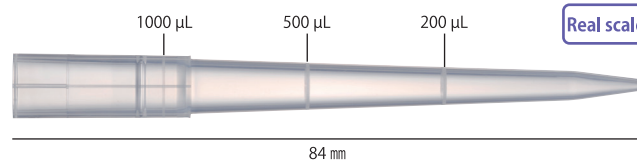

Real scale



\*: see below



Empty Rack for ECO PACK (1000  $\mu$ L)  
1298-757RA  
Material: Polycarbonate



Cat. No.	Item	Unit	Case
123R-757CS	1000 $\mu$ L, Long Tip, Graduated, Natural, "ECO PACK" Refill Stack	Sterilized 96 tips × 5 plates × 5 stacks	5 units
1298-757RA	Empty Rack for ECO PACK (1000 $\mu$ L)	5 racks	10 bags

**Pipette tip compatibility** • Watson NEXTY/NEXTY-S 100-1000  $\mu$ L / 1000  $\mu$ L (Fixed volume)  
• Eppendorf Reference 50-250  $\mu$ L (4910) / 100-1000  $\mu$ L  
• Gilson Pipetman P-1000 • Finn pipette F3 100-1000  $\mu$ L • Finn pipette Digital 100-1000  $\mu$ L  
• Nichiryo Nichipet EX 100-1000  $\mu$ L • Rainin Pipet-Lite SL-1000XLS • Capp ecopipette 100-1000  $\mu$ L

Note:(\*)ECO PACK are autoclavable after setting into tip rack. Repeated autoclaving may cause rack damaged.



ECO PACK

207  
10µL

## 10 µL, 50 mm, Long Tip

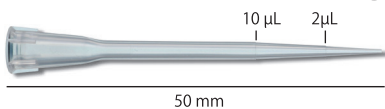

Real scale



\*: see below



Because of total 50 mm length of long tip, the pipette's nozzle does not touch the solution and/or the microtube with no concern of contamination even if the tip reaches the bottom of 1.5 mL microtube.



Ultrathin formed tip point enables complete liquid dispense.

Material: Polypropylene (pipette tip, plate)

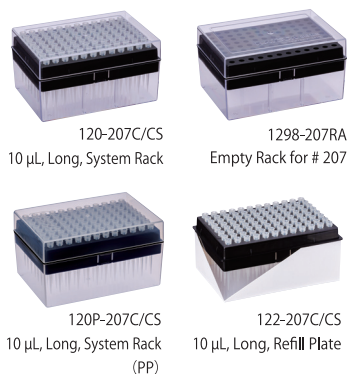

Cat. No.	Item	Packaging	Unit	Case
110-207C	10 µL, Long Tip, Graduated, Natural	Bulk	1000 tips	20 bags
* 120-207C	10 µL, Long Tip, Graduated, Natural	System Rack(PC)	96 tips×10 racks	5 units
* 120-207CS	10 µL, Long Tip, Graduated, Natural	Sterilized System Rack(PC)	96 tips×10 racks	5 units
* 1298-207RA	Empty Rack for # 207 (10 µL Long) and 1272-207CS / 127-10XS	—	10 racks	5 units
120P-207C	10 µL, Long Tip, Graduated, Natural	System Rack(PP)	96 tips×10 racks	5 units
120P-207CS	10 µL, Long Tip, Graduated, Natural	Sterilized System Rack(PP)	96 tips×10 racks	5 units
* 122-207C	10 µL, Long Tip, Graduated, Natural	Refill Plate	96 tips×10 plates	5 units
* 122-207CS	10 µL, Long Tip, Graduated, Natural	Sterilized Refill Plate	96 tips×10 plates	5 units

**Pipette tip compatibility** · Watson NEXTY/NEXTY-S 0.2-2 µL / 1-10 µL(Multi) / 10 µL(Fixed volume) · Eppendorf Reference 2-20 µL(Gray)  
 · Eppendorf Research V 0.1-2.5 µL / 0.5-10 µL(Multi) · Gilson Pipetman P-2 / P-10  
 · Finnpiptette Digital 0.2-2.0 µL / 0.5-10 µL(Multi) · Biohit Proline 0.1-2.5 µL / 0.5-10 µL(Multi)  
 · Nichiryo Nichipet EX 0.1-2 µL / 0.5-10 µL(Multi) · A&D MPA-10 / MPA-20

204  
10µL

## 10 µL, Short Tip

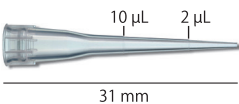

Real scale



\*: see below

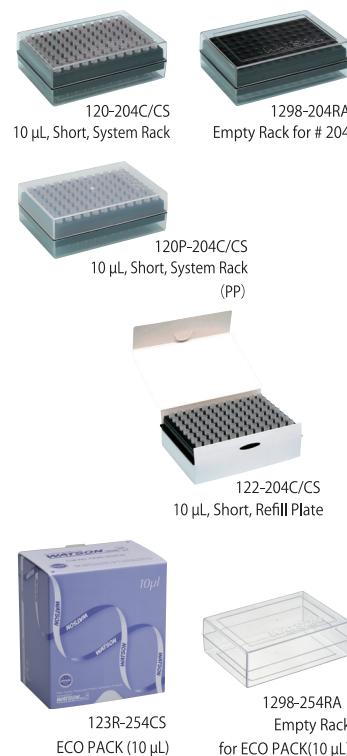

Cat. No.	Item	Packaging	Unit	Case
110-204C	10 µL, Short Tip, Graduated, Natural	Bulk	1000 tips	20 bags
* 120-204C	10 µL, Short Tip, Graduated, Natural	System Rack(PC)	96 tips×10 racks	5 units
* 120-204CS	10 µL, Short Tip, Graduated, Natural	Sterilized System Rack(PC)	96 tips×10 racks	5 units
* 1298-204RA	Empty Rack for # 204 (10 µL Short) and 1271-204CS / 127-10S	—	10 racks	5 units
120P-204C	10 µL, Short Tip, Graduated, Natural	System Rack(PP)	96 tips×10 racks	5 units
120P-204CS	10 µL, Short Tip, Graduated, Natural	Sterilized System Rack(PP)	96 tips×10 racks	5 units
* 122-204C	10 µL, Short Tip, Graduated, Natural	Refill Plate	96 tips×10 plates	5 units
* 122-204CS	10 µL, Short Tip, Graduated, Natural	Sterilized Refill Plate	96 tips×10 plates	5 units
* 123R-254CS	10 µL, Short Tip, Graduated, Natural, "ECO PACK", Refill Stack	Sterilized Stack Rack	96 tips×5 plates×10 stacks	5 units
* 1298-254RA	Empty Rack for ECO PACK(10 µL)	—	10 racks	10 bags

**Pipette tip compatibility** · Watson NEXTY/NEXTY-S 0.2-2 µL / 1-10 µL(Multi) / 10 µL(Fixed volume)  
 · Eppendorf Reference/ Research V 0.1-2.5 µL / 0.5-10 µL(Multi) · Gilson Pipetman P-2 / P-10  
 · Finnpiptette Digital 0.2-2.0 µL / 0.5-10 µL(Multi) · Biohit Proline 0.5-10 µL(Multi)  
 · Nichiryo Nichipet EX 0.1-2 µL / 0.5-10 µL(Multi) · A&D MPA-10 / MPA-20

Note:(\*)Refill plate type and ECO PACK are autoclavable after setting into tip rack. Repeated autoclaving may cause rack damaged.

**705**  
200µL

## 200 µL, Standard Tip

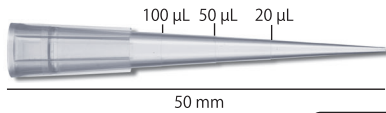

Real scale



Ultrathin formed tip point enables complete liquid dispense.

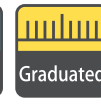

\*: see below

Material: Polypropylene (pipette tip)



Cat. No.	Item	Packaging	Unit	Case
110-705C	200 µL, Standard Tip, Graduated, Natural	Bulk	1000 tips	10 bags
111-705C	200 µL, Standard Tip, Graduated, Natural with Zipper Bag	Bulk	1000 tips	10 bags

### Three tip-systems available in the 705 series



#### ECO PACK

Speedy. Sterilized and ready to use

Material: Polypropylene (pipette tip, plate)



123R-755CS  
200 µL, ECO PACK



1298-755RA  
Empty Rack  
for ECO PACK (200 µL)



Lift a plate

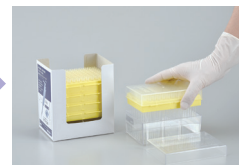

Place it into a rack



Refilling tips is completed

Cat. No.	Item	Packaging	Unit	Case
* 123R-755CS	200 µL, Standard Tip, Graduated, Natural, "ECO PACK" Refill Stack	Stack Rack	96 tips × 5 plates × 10 stacks	5 units
* 1298-755RA	Empty Rack for ECO PACK (200 µL)	—	10 racks	8 bags



#### NEXTY PACK

Economical. In combination with a NEXTY Rack

Material: Polypropylene (pipette tip)  
Polycarbonate (plate)



123NT-755C  
NEXTY Pack 200 µL



1298-NTS  
NEXTY Rack (S)

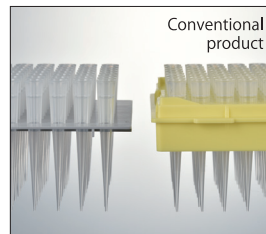

Thin wall design reduces waste compared to conventional product.



Place the Support Post\* inside the NEXTY Rack(S) before use. (\*Originally included)



Easy to Refill - just place a refill plate on the NEXTY Rack.

Cat. No.	Item	Packaging	Unit	Case
* 123NT-755C	200 µL, Standard Tip, Graduated, Natural, "NEXTY PACK" Refill Stack for NEXTY Rack(S)	Stack Rack	96 tips × 5 plates × 10 stacks	5 units
* 1298-NTS	NEXTY Rack (S)	—	1 piece	40 units



#### PP Rack

Material: Polypropylene (pipette tip, plate)



1201-705C/CS  
200 µL, PP Rack



1298-705RA  
Empty Rack for # 705 (PP)

Cat. No.	Item	Packaging	Unit	Case
1201-705C	200 µL, Standard Tip, Graduated, Natural	Rack(PP)	96 tips × 10 racks	5 units
1201-705CS	200 µL, Standard Tip, Graduated, Natural	Rack(PP)	96 tips × 10 racks	5 units
1298-705RA	Empty Rack for # 705 (200 µL) PP	—	10 racks	5 units

**Pipette tip compatibility**

- Watson NEXTY/NEXTY-S 2-20 µL / 10-100 µL (Multi) / 20-200 µL (Multi) / 20 µL • 100 µL • 200 µL (Fixed volume)
- Eppendorf Reference/ Research V 2-20 µL / 10-100 µL (Multi) / 50(20)-200 µL
- Gilson Pipetman P-20 / P-100 / P-200 • Finn pipette Digital 2-20 µL / 5-50 µL (Multi) / 10-100 µL / 20-200 µL
- Biohit Proline 2-20 µL / 5-50 µL (Multi) / 10-100 µL / 20-200 µL
- Nichiryo Nichipet EX 2-20 µL / 10-100 µL / 20-200 µL / 5-50 µL (Multi) / 40-200 µL (Multi) • A&D MPA-200

Note: (\*) ECO PACK and NEXTY PACK are autoclavable after setting into tip rack. Repeated autoclaving may cause rack damaged.

Pipette Tips

703  
200µL

## 200 µL Standard Tip



53 mm

Real scale



\*: see below

Material: Polypropylene (pipette tip, plate)

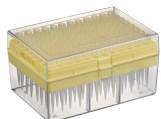

120-703C/CS  
200 µL, System Rack

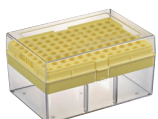

1298-703RA  
Empty Rack for # 503, # 703

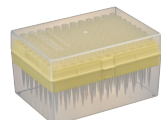

120P-703C/CS  
200 µL, System Rack(PP)

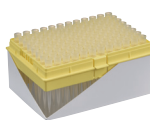

122-703C/CS  
200 µL, Refill Plate



Cat. No.	Item	Packaging	Unit	Case
110-703C	200 µL, Standard Tip, Natural	Bulk	1000 tips	30 bags
*120-703C	200 µL, Standard Tip, Natural	System Rack(PC)	96 tips×10 racks	5 units
*120-703CS	200 µL, Standard Tip, Natural <b>Sterilized</b>	System Rack(PC)	96 tips×10 racks	5 units
*1298-703RA	Empty Rack for # 503 /# 703 (200 µL) and 127-20S, 100S, 200S / 126-20S, 100S / 1272-703CS	—	10 racks	5 units
120P-703C	200 µL, Standard Tip, Natural	System Rack(PP)	96 tips×10 racks	5 units
120P-703CS	200 µL, Standard Tip, Natural <b>Sterilized</b>	System Rack(PP)	96 tips×10 racks	5 units
*122-703C	200 µL, Standard Tip, Natural	Refill Plate	96 tips×10 plates	5 units
*122-703CS	200 µL, Standard Tip, Natural <b>Sterilized</b>	Refill Plate	96 tips×10 plates	5 units

**Pipette tip compatibility** • Watson NEXTY/NEXTY-S 2-20 µL / 10-100 µL(Multi) / 20-200 µL(Multi) / 20 µL•100 µL•200 µL(Fixed volume)  
 •Eppendorf Reference/ Research V 2-20 µL / 10-100 µL(Multi) / 50(20)-200 µL  
 •Gilson Pipetman P-20 / P-100 / P-200 •Finnpipette Digital 2-20 µL / 5-50 µL(Multi) / 10-100 µL / 20-200 µL  
 •Biohit Proline 2-20 µL / 5-50 µL(Multi) / 10-100 µL / 20-200 µL  
 •Nichiryo Nichipet EX 2-20 µL / 10-100 µL / 20-200 µL •A&D MPA-200

503  
200µL



53 mm

Real scale



\*: see below

Material: Polypropylene (pipette tip, plate)

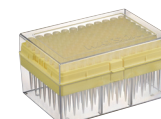

120-503C/CS  
200 µL, System Rack

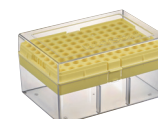

1298-703RA  
Empty Rack for # 503, # 703

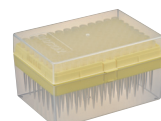

120P-503C/CS  
200 µL, System Rack(PP)

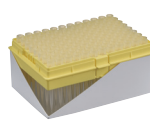

122-503C/CS  
200 µL, Refill Plate



Cat. No.	Item	Packaging	Unit	Case
110-503C	200 µL, Standard Tip, Natural	Bulk	1000 tips	30 bags
*120-503C	200 µL, Standard Tip, Natural	System Rack(PC)	96 tips×10 racks	5 units
*120-503CS	200 µL, Standard Tip, Natural <b>Sterilized</b>	System Rack(PC)	96 tips×10 racks	5 units
*1298-703RA	Empty Rack for # 503 /# 703 (200 µL) and 127-20S, 100S, 200S / 126-20S, 100S / 1272-703CS	—	10 racks	5 units
120P-503C	200 µL, Standard Tip, Natural	System Rack(PP)	96 tips×10 racks	5 units
120P-503CS	200 µL, Standard Tip, Natural <b>Sterilized</b>	System Rack(PP)	96 tips×10 racks	5 units
*122-503C	200 µL, Standard Tip, Natural	Refill Plate	96 tips×10 plates	5 units
*122-503CS	200 µL, Standard Tip, Natural <b>Sterilized</b>	Refill Plate	96 tips×10 plates	5 units

**Pipette tip compatibility** • Watson NEXTY/NEXTY-S 2-20 µL / 10-100 µL(Multi) / 20-200 µL(Multi) / 20 µL•100 µL•200 µL(Fixed volume)  
 •Eppendorf Reference/ Research V 2-20 µL / 10-100 µL(Multi) / 50(20)-200 µL  
 •Gilson Pipetman P-20 / P-100 / P-200 •Finnpipette Digital 2-20 µL / 5-50 µL(Multi) / 10-100 µL / 20-200 µL  
 •Biohit Proline 2-20 µL / 5-50 µL(Multi) / 10-100 µL / 20-200 µL  
 •Nichiryo Nichipet EX 2-20 µL / 10-100 µL / 20-200 µL •A&D MPA-200

Note:(\*)Refill plate type is autoclavable after setting into tip rack. Repeated autoclaving may cause rack damaged.



**801**  
250µL

## 250 µL, 89 mm Long Tip

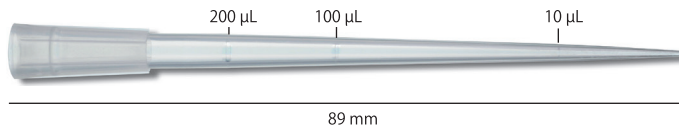

Real scale



\*: see below



120-801C/CS  
250 µL, Long, System Rack



1298-801RA  
Empty Rack for # 801

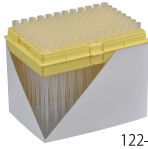

122-801C/CS  
250 µL, Long, Refill Plate

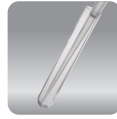

Best for the use of 5 mL test tube with its length 75 mm.

Note: Please read precautions of the use of 801 series tips on page 28.

Material: Polypropylene (pipette tip, plate)



Cat. No.	Item	Packaging	Unit	Case
110-801C	250 µL, Long Tip, Graduated, Natural	Bulk	1000 tips	10 bags
* 120-801C	250 µL, Long Tip, Graduated, Natural	System Rack(PC)	96 tips × 10 racks	5 units
* 120-801CS	250 µL, Long Tip, Graduated, Natural <b>Sterilized</b>	System Rack(PC)	96 tips × 10 racks	5 units
* 1298-801RA	Empty Rack for # 801 (250 µL Long) and 1272-801CS / 127-200XS	—	10 racks	5 units
* 122-801C	250 µL, Long Tip, Graduated, Natural	Refill Plate	96 tips × 10 plates	5 units
* 122-801CS	250 µL, Long Tip, Graduated, Natural <b>Sterilized</b>	Refill Plate	96 tips × 10 plates	5 units

### Pipette tip compatibility

- Watson NEXTY/NEXTY-S 10-100 µL / 20-200 µL(Multi) / 100 µL • 200 µL(Fixed volume)
- Eppendorf Reference/ Research V 2-20 µL / 10-100 µL / 50(20)-200 µL
- Gilson Pipetman P-100 / P-200 • Finnpiptette Digital 2-20 µL / 5-50 µL / 10-100 µL / 20-200 µL
- Biohit Proline 2-20 µL / 5-50 µL / 10-100 µL / 20-200 µL • Nichiryo Nichipet EX 2-20 µL / 10-100 µL / 20-200 µL
- A&D MPA-200

**505**  
300µL



Real scale



\*: see below



120-505C/CS  
300 µL, System Rack



1298-503RA  
Empty Rack for # 505

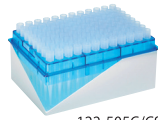

122-505C/CS  
300 µL, Refill Plate



Cat. No.	Item	Packaging	Unit	Case
110-505C	300 µL, Standard Tip, Natural	Bulk	1000 tips	30 bags
* 120-505C	300 µL, Standard Tip, Natural	System Rack(PC)	96 tips × 10 racks	5 units
* 120-505CS	300 µL, Standard Tip, Natural <b>Sterilized</b>	System Rack(PC)	96 tips × 10 racks	5 units
* 1298-503RA	Empty Rack for # 505 (300 µL) and 126-200S	—	10 racks	5 units
* 122-505C	300 µL, Standard Tip, Natural	Refill Plate	96 tips × 10 plates	5 units
* 122-505CS	300 µL, Standard Tip, Natural <b>Sterilized</b>	Refill Plate	96 tips × 10 plates	5 units

### Pipette tip compatibility

- Watson NEXTY/NEXTY-S 10-100 µL / 20-200 µL(Multi) / 50-300 µL(Multi) / 100 µL • 200 µL(Fixed volume)
- Eppendorf Reference/ Research V 10-100 µL(Multi) / 50(20)-200 µL / 30-300 µL(Multi)
- Gilson Pipetman P-200 / 20-300 µL(Multi) • Finnpiptette Digital 10-100 µL / 20-200 µL / 50-300 µL(Multi)
- Biohit Proline 10-100 µL / 20-200 µL / 50-300 µL(Multi)
- Nichiryo Nichipet EX 10-100 µL / 20-200 µL / 50-300 µL(Multi) • A&D MPA-200

Note:(\*)Refill plate type is autoclavable after setting into tip rack. Repeated autoclaving may cause rack damaged.



Pipette Tips



## 1000 µL, Thin wall Soft fitting Tip

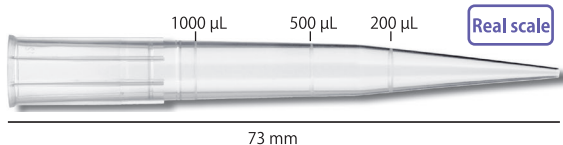

\*:see below

Material: Polypropylene (pipette tip, plate)

Pipette Tips

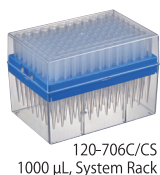

Cat. No.	Item	Packaging	Unit	Case
110-706C	1000 µL, Standard Tip, Graduated, Natural	Bulk	1000 tips	10 bags
* 120-706C	1000 µL, Standard Tip, Graduated, Natural	System Rack(PC)	96 tips × 10 racks	5 units
* 120-706CS	1000 µL, Standard Tip, Graduated, Natural <b>Sterilized</b>	System Rack(PC)	96 tips × 10 racks	5 units
* 1298-802RA	Empty Rack for # 706 / # 804 (1000 µL) and 126 / 127-1000S	—	10 racks	5 units
120P-706C	1000 µL, Standard Tip, Graduated, Natural	System Rack(PP)	96 tips × 10 racks	5 units
120P-706CS	1000 µL, Standard Tip, Graduated, Natural <b>Sterilized</b>	System Rack(PP)	96 tips × 10 racks	5 units
* 122-706C	1000 µL, Standard Tip, Graduated, Natural	Refill Plate	96 tips × 10 plates	5 units
* 122-706CS	1000 µL, Standard Tip, Graduated, Natural <b>Sterilized</b>	Refill Plate	96 tips × 10 plates	5 units

120-706C/CS  
1000 µL, System Rack

1298-802RA  
Empty Rack  
for # 706, # 804

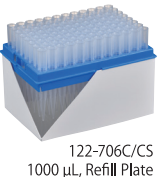
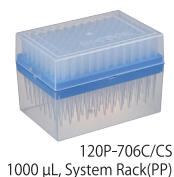

### Pipette tip compatibility

- Watson NEXTY/NEXTY-S 100-1000 µL / 1000 µL (Fixed volume)
- Eppendorf Reference/Research V 50-250 µL (4910) / 100-1000 µL
- Gilson Pipetman P-1000
- Finn pipette Digital 100-1000 µL
- Biohit Proline 100-1000 µL
- Nichiryo Nichipet EX 100-1000 µL
- A&D MPA-1200

## Features of Watson Tip System



### Tough & extremely durable

The body and lid, made of polycarbonate(PC), does not lose its shape over time use. It can also be autoclaved repetitively.

**Note:** Repeated autoclaving may cause rack damaged.

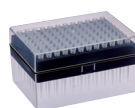

### Low cost and high chemical resistant

The body and lid, made of Polypropylene(PP) is lightweight, durable, and highly resistant to chemicals and heat. Because of its inexpensive cost compared with System Rack (PC), this System Rack(PP) can be disposed as one time use if used with non-sterilized long tip, or can be reused even after autoclaving if tips are manually refilled.

**Note:** The rack made of PP shrinks slightly after autoclaving, consequently refill plate cannot be used.



### Easy, Handy, and Eco-Friendly

One-touch replacement for the System Rack. The paper cover can be recycled.

**Note:** Use a PC (polycarbonate) rack when refilling tips.

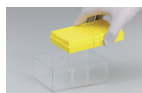

Remove the old plate.



Place the new plate. Remove paper skirt.

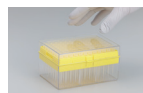

Refilling tips is complete.



### Nuclease-free certificate

This mark shows RNase/DNase/Human-DNA free. Products with this mark are manufactured in the clean room under our high quality control, and inspected to meet our strict quality standards.

RNase/DNase-free certificates can be issued for each lot upon your request.

**Note: (\*) Refill plate type is autoclavable after setting into tip rack. Repeated autoclaving may cause rack damaged.**

**804**  
1000µL

## 1000 µL, 80 mm Long Tip

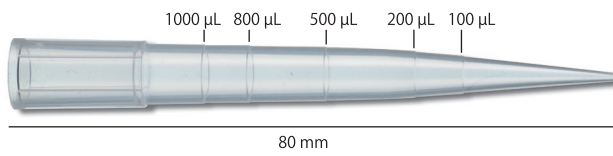

Real scale



\*: see below

Material: Polypropylene (pipette tip, plate)

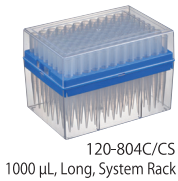

120-804C/CS  
1000 µL, Long, System Rack



1298-802RA  
Empty Rack  
for # 706, # 804



Cat. No.	Item	Packaging	Unit	Case
110-804C	1000 µL, Long Tip, Graduated, Natural	Bulk	1000 tips	10 bags
* 120-804C	1000 µL, Long Tip, Graduated, Natural	System Rack(PC)	96 tips×10 racks	5 units
* 120-804CS	1000 µL, Long Tip, Graduated, Natural <b>Sterilized</b>	System Rack(PC)	96 tips×10 racks	5 units
* 1298-802RA	Empty Rack for # 706 /# 804 (1000 µL) and 126 / 127-1000S	—	10 racks	5 units
120P-804C	1000 µL, Long Tip, Graduated, Natural	System Rack(PP)	96 tips×10 racks	5 units
120P-804CS	1000 µL, Long Tip, Graduated, Natural <b>Sterilized</b>	System Rack(PP)	96 tips×10 racks	5 units
* 122-804C	1000 µL, Long Tip, Graduated, Natural	Refill Plate	96 tips×10 plates	5 units
* 122-804CS	1000 µL, Long Tip, Graduated, Natural <b>Sterilized</b>	Refill Plate	96 tips×10 plates	5 units

### Pipette tip compatibility

- Watson NEXTY/NEXTY-S 100-1000 µL / 1000 µL (Fixed volume)
- Eppendorf Reference/ Research V 50-250 µL(4910) / 100-1000 µL
- FinnpiPET Digital 100-1000 µL
- Biohit ProLine 100-1000 µL
- Nichiryo Nichipet EX 100-1000 µL
- A&D MPA-1200
- Gilson Pipetman P-1000

**806**  
1000µL

## 1000 µL, Thin wall soft fitting Long Tip

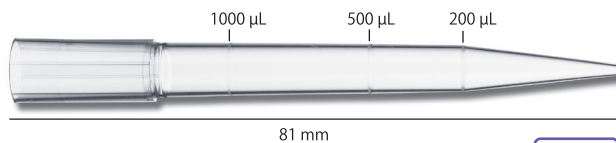

Real scale

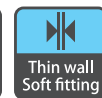

\*: see below

Material: Polypropylene (pipette tip, plate)



120-806C/CS  
1000 µL, Long, System Rack



1298-806RA  
Empty Rack for # 806



Cat. No.	Item	Packaging	Unit	Case
110-806C	1000 µL, Long Tip, Graduated, Natural, 9 mm Pitch	Bulk	1000 tips	10 bags
* 120-806C	1000 µL, Long Tip, Graduated, Natural, 9 mm Pitch	System Rack(PC)	96 tips×10 racks	5 units
* 120-806CS	1000 µL, Long Tip, Graduated, Natural, 9 mm Pitch <b>Sterilized</b>	System Rack(PC)	96 tips×10 racks	5 units
* 1298-806RA	Empty Rack for # 806 (1000 µL)	—	10 racks	5 units
120P-806C	1000 µL, Long Tip, Graduated, Natural, 9 mm Pitch	System Rack(PP)	96 tips×10 racks	5 units
120P-806CS	1000 µL, Long Tip, Graduated, Natural, 9 mm Pitch <b>Sterilized</b>	System Rack(PP)	96 tips×10 racks	5 units
* 122-806C	1000 µL, Long Tip, Graduated, Natural, 9 mm Pitch	Refill Plate	96 tips×10 plates	5 units
* 122-806CS	1000 µL, Long Tip, Graduated, Natural, 9 mm Pitch <b>Sterilized</b>	Refill Plate	96 tips×10 plates	5 units

### Pipette tip compatibility

- Watson NEXTY/NEXTY-S 100-1000 µL / 1000 µL (Fixed volume)
- Eppendorf Reference/ Research V 50-250 µL(4910) / 100-1000 µL
- FinnpiPET Digital 100-1000 µL
- Biohit ProLine 100-1000 µL
- Nichiryo Nichipet EX 100-1000 µL
- Gilson Pipetman P-1000

Note:(\*)Refill plate type is autoclavable after setting into tip rack. Repeated autoclaving may cause rack damaged.



Pipette Tips

**805**  
1200µL

## 1200 µL, Extra Long Tip

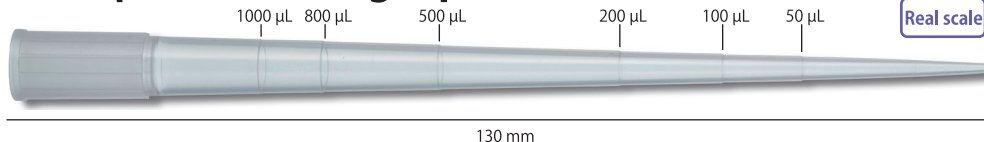

120-805C/CS  
1200 µL, Extra Long  
System Rack



1298-805RA  
Empty Rack for # 805

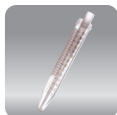

It reaches to the inner bottom of 15 mL / 50 mL centrifuge tube. No concern of contamination of the pipette's nozzle with the solution and/or the inner part of centrifuge tube.



\*: see below

Material: Polypropylene (pipette tip, plate)



Cat. No.	Item	Packaging	Unit	Case
110-805C	1200 µL, Extra Long Tip, Graduated, Natural	Bulk	1000 tips	10 bags
* 120-805C	1200 µL, Extra Long Tip, Graduated, Natural	System Rack(PC)	96 tips × 10 racks	5 units
* 120-805CS	1200 µL, Extra Long Tip, Graduated, Natural <b>Sterilized</b>	System Rack(PC)	96 tips × 10 racks	5 units
* 1298-805RA	Empty Rack for # 805 (1200 µL Extra Long) and 126 / 127-1200S	—	10 racks	5 units
* 122-805C	1200 µL, Extra Long Tip, Graduated, Natural	Refill Plate	96 tips × 10 plates	5 units
* 122-805CS	1200 µL, Extra Long Tip, Graduated, Natural <b>Sterilized</b>	Refill Plate	96 tips × 10 plates	5 units

**Pipette tip compatibility** · Watson NEXTY/NEXTY-S 100-1000 µL / 1000 µL (Fixed volume)  
 · Eppendorf Reference/ Research V 50-250 µL (4910) / 100-1000 µL  
 · Gilson Pipetman P-1000 · Finnpiptette Digital 100-1000 µL  
 · Biohit Proline 100-1000 µL · Nichiryō Nichipet EX 100-1000 µL

**401**  
5 mL

## 5000 µL, 130 mm

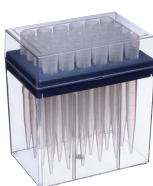
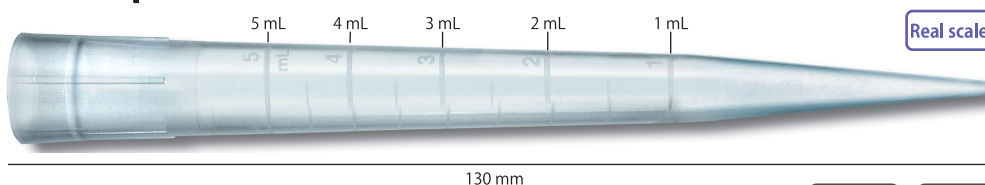

120-401C/CS  
5000 µL, System Rack



1298-401RA  
Empty Rack for # 401



Cat. No.	Item	Packaging	Unit	Case
110-401C	5000 µL, Standard Tip, Graduated, Natural	Bulk	250 tips	10 bags
* 120-401C	5000 µL, Standard Tip, Graduated, Natural	System Rack(PC)	24 tips × 10 racks	5 units
* 120-401CS	5000 µL, Standard Tip, Graduated, Natural <b>Sterilized</b>	System Rack(PC)	24 tips × 10 racks	5 units
* 1298-401RA	Empty Rack for # 401 (5000 µL) and 126-5000S	—	10 racks	5 units

**Pipette tip compatibility** · Watson NEXTY/NEXTY-S 50-5000 µL / 5000 µL (Fixed volume)  
 · Gilson Pipetman P-5000 · Socorex Acura 0.5 - 5 mL

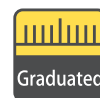

\*: see below

Material: Polypropylene (pipette tip, plate)

### PRECAUTIONS : When using the long tip or extra-long tip

The liquid is affected by pressure, dependent on the size / length of the tip. Therefore when you use a certain pipette in combination with a long tip, it is necessary to adjust the scale on the pipette tip's height (=height of sample) in accordance to the level to which liquid has been drawn in.

If an 801\* tip (250 µL) or an 805\*\* tip (1200 µL) is used, it is necessary to make adjustments.

**Note: The shape / size of the following tips is identical.**

\*Tip # 801: Tip # 200XS series

\*\*Tip # 805: Tip # 1200S series

Example: Adjustment of height  
 The level when dispensing with 1000 µL on the pipette scale.

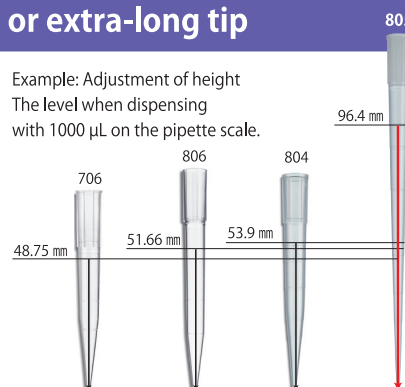

Note:(\*)Refill plate type is autoclavable after setting into tip rack. Repeated autoclaving may cause rack damaged.



Low Retention Tips

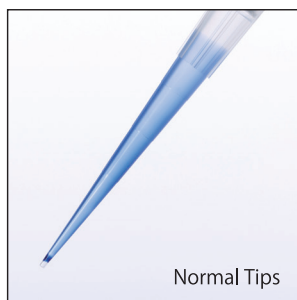
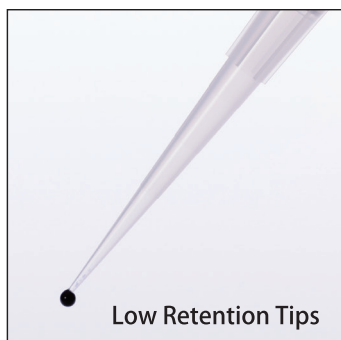

### Superior water repellency

Utilizing a unique blend of resin materials, combined with Watson's high-precision molds and molding technology, these tips demonstrate superior water repellency. By realizing a significant reduction in sample loss due to adhesion, our low retention tips enable reliable data acquisition in research settings where high precision and reproducibility are required.



### 10 µL, Short Tip, Graduated

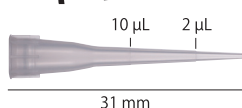

Real scale

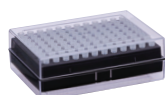
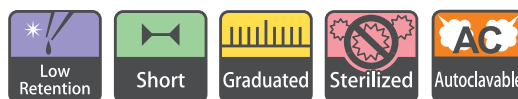

121-214CLS  
10 µL, Low Retention Tips  
System Rack



Cat. No.	Item	Packaging	Unit	Case
112-214CL	10µL, Low Retention Short Tips, Graduated, Natural	Bulk	1,000 tips	20 bags
*121-214CLS	10µL, Low Retention Short Tips, Graduated, Natural <b>Sterilized</b>	System Rack(PC)	96 tips × 10 racks	5 units

Material: Polypropylene (pipette tip, plate)

**Pipette tip compatibility**

- Watson NEXTY/NEXTY-S 0.2-2 µL / 1-10 µL (Multi) / 10 µL (Fixed volume)
- Eppendorf Reference/ Research V 0.1-2.5 µL / 0.5-10 µL (Multi)
- Gilson Pipetman P-2 / P-10
- Finnpiptette Digital 0.2-2.0 µL / 0.5-10 µL (Multi)
- Biohit Proline 0.5-10 µL (Multi)
- Nichiryo Nichipet EX 0.1-2 µL / 0.5-10 µL (Multi)
- A&D MPA-10 / MPA-20



### 200 µL, Graduated



Real scale



121-715CLS  
200 µL, Low Retention Tips  
System Rack



Cat. No.	Item	Packaging	Unit	Case
112-715CL	200µL, Low Retention Tips, Graduated, Natural	Bulk	1,000 tips	10 bags
*121-715CLS	200µL, Low Retention Tips, Graduated, Natural <b>Sterilized</b>	System Rack(PC)	96 tips × 10 racks	5 units

Material: Polypropylene (pipette tip, plate)

**Pipette tip compatibility**

- Watson NEXTY/NEXTY-S 2-20 µL / 10-100 µL (Multi) / 20-200 µL (Multi) / 20 µL • 100 µL • 200 µL (Fixed volume)
- Eppendorf Reference/ Research V 2-20 µL / 10-100 µL (Multi) / 50(20)-200 µL
- Gilson Pipetman P-20 / P-100 / P-200
- Finnpiptette Digital 2-20 µL / 5-50 µL (Multi) / 10-100 µL / 20-200 µL
- Biohit Proline 2-20 µL / 5-50 µL (Multi) / 10-100 µL / 20-200 µL
- Nichiryo Nichipet EX 2-20 µL / 10-100 µL / 20-200 µL / 5-50 µL (Multi) / 40-200 µL (Multi)
- A&D MPA-200

## Liquid Residue Test

### [Test Method]

A volume of 200 µL was aspirated and then fully expelled into the same container, with the weight difference representing the amount of liquid remaining in the tip for comparison.

### [Test Results]

Compared to the low retention tips of Company A, B, and C, the superiority has been confirmed. Furthermore, when compared to the same type of Watson's normal tips, a significant reduction in residual amount has been observed, indicating sufficient development of water repellency.

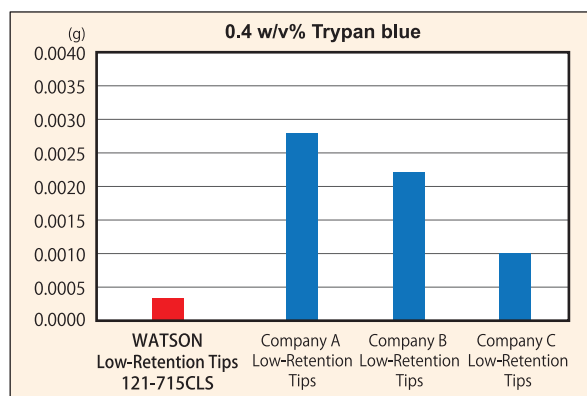

Figure 1: Residual Amount in the Tip

Note:(\*)Repeated autoclaving may cause rack damaged.

### Large-bore Tips

Large-bore design is suitable for pipetting the samples of the cell or the high-viscosity such as glycerol.

200  $\mu$ L

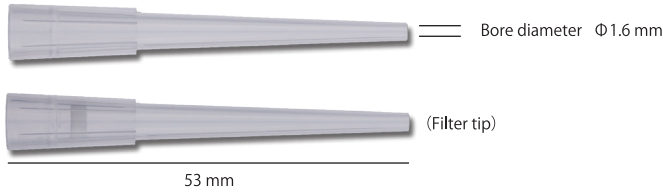

Bulk only

Material: Polypropylene (pipette tip, plate) Polyethylene (filter)



Cat. No.	Item	Packaging	Unit	Case
113-744C	Large-bore Tip for 200 $\mu$ L, Natural	Bulk	1000 tips	10 bags
120P-744CS	Large-bore Tip for 200 $\mu$ L, Natural <b>Sterilized</b>	System Rack(PP)	96 tips $\times$ 10 racks	5 units
124P-744CS	Large-bore Filter Tip for 200 $\mu$ L, Natural <b>Sterilized</b>	System Rack(PP)	96 tips $\times$ 10 racks	5 units

**Pipette tip compatibility**

- Watson NEXTY/NEXTY-S 20-200  $\mu$ L(Multi) / 200  $\mu$ L(Fixed volume)
- Eppendorf Reference/ Research V 2-20  $\mu$ L / 10-100  $\mu$ L(Multi) / 50(20)-200  $\mu$ L
- Gilson Pipetman P-20 / P-100 / P-200 • Finnpiquette Digital 2-20  $\mu$ L / 5-50  $\mu$ L(Multi) / 10-100  $\mu$ L / 20-200  $\mu$ L
- Biohit Proline 2-20  $\mu$ L / 5-50  $\mu$ L(Multi) / 10-100  $\mu$ L / 20-200  $\mu$ L
- Nichiryo Nichipet EX 2-20  $\mu$ L / 10-100  $\mu$ L / 20-200  $\mu$ L • A&D MPA-200

1000  $\mu$ L

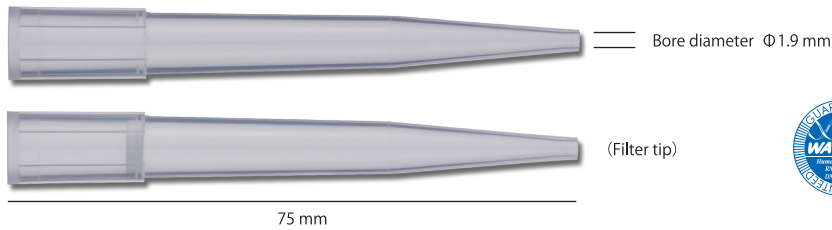

Bulk only

Material: Polypropylene (pipette tip, plate) Polyethylene (filter)



Cat. No.	Item	Packaging	Unit	Case
113-844C	Large-bore Tip for 1000 $\mu$ L, Natural	Bulk	1000 tips	10 bags
120P-844CS	Large-bore Tip for 1000 $\mu$ L, Natural <b>Sterilized</b>	System Rack(PP)	96 tips $\times$ 10 racks	5 units
124P-844CS	Large-bore Filter Tip for 1000 $\mu$ L, Natural <b>Sterilized</b>	System Rack(PP)	96 tips $\times$ 10 racks	5 units

**Pipette tip compatibility**

- Watson NEXTY/NEXTY-S 100-1000  $\mu$ L / 1000  $\mu$ L(Fixed volume)
- Eppendorf Reference/ Research V 50-250  $\mu$ L(4910) / 100-1000  $\mu$ L • Gilson Pipetman P-1000
- Finnpiquette Digital 100-1000  $\mu$ L • Biohit Proline 100-1000  $\mu$ L • Nichiryo Nichipet EX 100-1000  $\mu$ L
- A&D MPA-1200



**Gel Loading Tips**

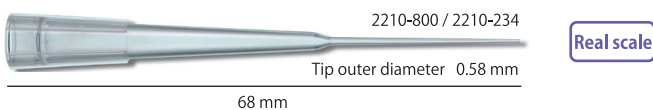
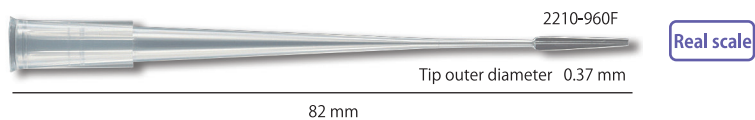
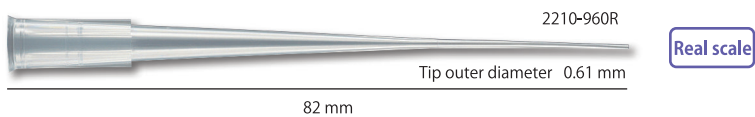

DNase/RNase Free



Cat. No.	Item	Packaging	Unit
2210-960R	Gel Loading Tips, 1-200 µL, Round type	Rack	96 tips×2 racks / unit
2210-960F	Gel Loading Tips, 1-200 µL, Flat type	Rack	96 tips×2 racks / unit
2210-800	Gel Loading Tips, 0.5-200 µL, Round type	Bulk	1000 tips
2210-234	Gel Loading Tips, 0.5-200 µL, Round type	Rack	204 tips×1 rack

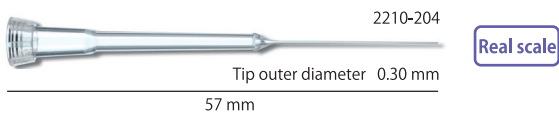

DNase/RNase Free



Cat. No.	Item	Packaging	Unit
2210-204	Gel Loading Tips, 0.5-10 µL, Round type, Rack with 204 tips	Rack	204 tips×1 rack

### Empty Racks

- Empty Rack is comprised of rack, plate and lid. **(Note: Tips are not included.)**
- Empty Racks are suitable for bulk tip loading or refill plates.

Material: Polycarbonate (rack) \*1298-705RA, 1298-PPS, 1298-PPM: Polypropylene  
Polypropylene (plate) \*\*1298-503RA: Polycarbonate



\*: see below

1298-207RA

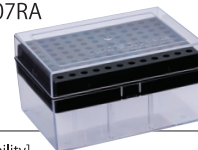

[Tip compatibility]  
110-207C • 122-207C • 122-207CS  
(filter tips) 127-10XS • 1272-207CS • 1272-207CLS

1298-204RA



[Tip compatibility]  
110-204C • 122-204C • 122-204CS • 112-214CL  
(filter tips) 127-10S • 1271-204CS

1298-254RA



[Tip compatibility]  
ECO PACK10 µL: 123R-254CS

1298-503RA\*\*

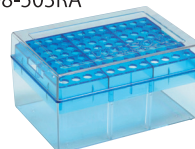

[Tip compatibility]  
110-505C • 122-505C • 122-505CS  
(filter tips) 126-300S

1298-703RA

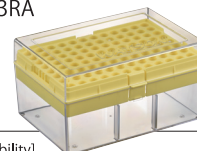

[Tip compatibility]  
110-503C • 122-503C • 122-503CS •  
110-703C • 122-703C • 122-703CS • 113-744C  
(filter tips) 127-20S • 127-100S • 127-200S •  
126-20S • 126-100S • 1272-703CS • 1272-703CLS

1298-705RA\*



[Tip compatibility]  
110-705C • 111-705C • 112-715CL

1298-755RA



[Tip compatibility]  
ECO PACK200 µL: 123R-755CS

1298-801RA

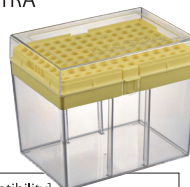

[Tip compatibility]  
110-801C • 122-801C • 122-801CS  
(filter tips) 127-200XS • 1272-801CS

1298-802RA

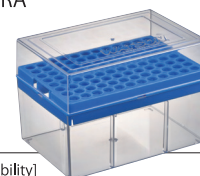

[Tip compatibility]  
110-706C • 122-706C • 122-706CS •  
110-804C • 122-804C • 122-804CS • 113-844C  
(filter tips) 127-1000S • 126-1000S • 126-1000LS

1298-806RA



[Tip compatibility]  
110-806C • 122-806C • 122-806CS

1298-757RA



[Tip compatibility]  
ECO PACK1000 µL: 123R-757CS

1298-805RA



[Tip compatibility]  
110-805C • 122-805C • 122-805CS  
(filter tips) 127-1200S • 126-1200S

1298-401RA



[Tip compatibility]  
110-401C  
(filter tips) 126-5000S

1298-PPS\*



[Tip compatibility]  
122-207C • 122-207CS • 122-204C • 122-204CS •  
123R-254CS • 122-703C • 122-703CS •  
122-503C • 122-503CS • 123R-755CS •  
122-505C • 122-505CS  
(filter tips) 127-10S • 127-10XS • 1271-204CS •  
1272-207CS • 127-20S • 126-20S • 127-100S •  
126-100S • 127-200S • 1272-703CS • 126-300S •  
1272-207CLS • 1272-703CLS

1298-PPM\*



[Tip compatibility]  
122-706C • 122-706CS • 122-804C • 122-804CS •  
122-806C • 122-806CS • 123R-757CS  
(filter tips) 127-1000S • 126-1000S • 126-1000LS

Cat. No.	Item	Dimensions	Unit	Case
* 1298-207RA	Empty Rack for # 207(10 µL Long) and 1272-207CS / 127-10XS	118 × 82 × 64 mm	10 racks	5 units
* 1298-204RA	Empty Rack for # 204(10 µL Short) and 1271-204CS / 127-10S	118 × 82 × 40 mm	10 racks	5 units
* 1298-254RA	Empty Rack for ECO PACK(10 µL)	118 × 82 × 40 mm	10 racks	10 bags
* 1298-503RA	Empty Rack for # 505(300 µL) and 126-300S	118 × 82 × 63 mm	10 racks	5 units
* 1298-703RA	Empty Rack for # 503 / # 703(200 µL) and 127-20S, 100S, 200S / 126-20S, 100S / 1272-703CS	118 × 82 × 64 mm	10 racks	5 units
1298-705RA	Empty Rack for # 705(200 µL)	118 × 82 × 62 mm	10 racks	5 units
* 1298-755RA	Empty Rack for ECO PACK(200 µL)	118 × 82 × 62 mm	10 racks	8 bags
* 1298-801RA	Empty Rack for # 801(250 µL Long) and 1272-801CS / 127-200XS	118 × 82 × 101 mm	10 racks	5 units
* 1298-802RA	Empty Rack for # 706 / # 804(1000 µL) and 126 / 127-1000S	131 × 89 × 92 mm	10 racks	5 units
* 1298-806RA	Empty Rack for # 806(1000 µL)	131 × 89 × 93 mm	10 racks	5 units
* 1298-757RA	Empty Rack for ECO PACK(1000 µL)	131 × 89 × 89.5 mm	5 racks	10 bags
* 1298-805RA	Empty Rack for # 805(1200 µL Extra Long) and 126 / 127-1200S	131 × 89 × 143 mm	10 racks	5 units
* 1298-401RA	Empty Rack for # 401(5000 µL) and 126-5000S	131 × 89 × 143 mm	10 racks	5 units
* 1298-PPS	PP Hinged Rack S for # 207 / # 204 / # 503 / # 505 / # 703 and # 705	129.4 × 92.2 × 67.7 mm	10 racks	5 units
* 1298-PPM	PP Hinged Rack M for # 706 / # 804 / # 806 and 123R-757CS	143.9 × 102.9 × 98.8 mm	5 racks	5 units

Note: (\*) Refill plate type is autoclavable after setting into tip rack. Repeated autoclaving may cause rack damaged.



**Rack Joint**

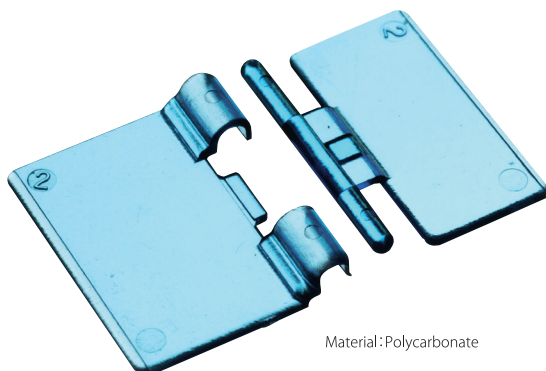

Material: Polycarbonate

- With Rack Joint as a hinge, the lid can be connected to the case of system rack.
- The adhesive tape on the Rack Joint's back is prepared for quick installation.
- Rack Joint can be used for both system rack made of polycarbonate and polypropylene.
- Autoclavable.

**\*Not suitable for PP racks; 1201-705C, 1201-705CS, 1298-705RA**

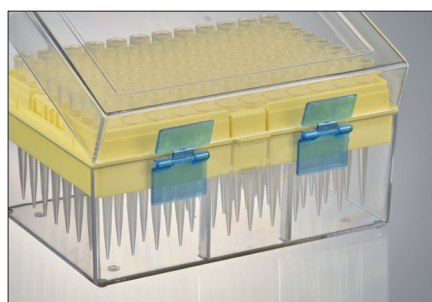

\*:see below

Cat. No.	Item	Unit	Case
172-PP	Rack Joint, Hinge parts for System Rack	10 sets	50 bags



Rack Joint

Note:(\*)Repeated autoclaving may cause rack damaged.